

 **i Make**™

The next generation shooting machine



Table of Contents

Getting Started

Setting up iMake.....	page 4-5
Collapsing the net system	page 6
Tightening the net	page 6

Parts of the iMake

Consistent Air Technology	page 8
Court Smart Technology	page 8
Touch Pad Control Panel	page 8
Caution	page 8

Machine Overview

Beeper.....	page 9
Timer Mode	page 9
Remote Mode	page 9
Multi-Ball Mode.....	page 10
Teach Mode	page 10
Custom Drills	page 11
Predefined Drills	page 11
Adjustable Ball Speed	page 11
Adjustable Rotation	page 11
Manual Rotation.....	page 11
Test Buttons	page 11
Remote	page 12
Wireless Shots Made Counter	page 12
Net System	page 12
Mobile Stand	page 12
Password.....	page 13
Changing Password	page 13

Modes of Operation

Timer Mode	page 14
Remote Mode	page 16
Multi-Ball Mode.....	page 18
Teach Mode	page 20
Saving a Custom Drill	page 22
Predefined Drills	pages 24-26

Shots Made Counter and Pole (optional)

Storage	page 27
Using the Shots Made Counter	page 27
Charging the Shots Made Counter.....	page 27
To ensure an accurate reading	page 27
Resetting Counter	page 27

Diagnostic Menu

Diagnostic Menu Descriptions

Troubleshooting

iMake Warranty

Getting Started - Setting up iMake and iMake Net System

To raise the net, the iMake must be horizontal with the frame.
Follow these steps to rotate the iMake.

1. Plug in iMake.
2. Press Power button.

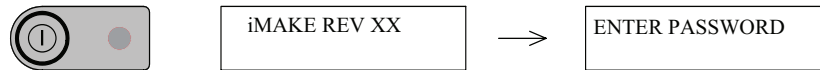

POWER

3. Enter the default password of "999", pressing Enter after each character, or use your remote to unlock the iMake by pressing the button once. See page 13 to change and create your own password.

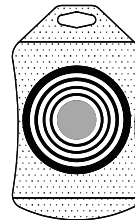

4. Press the down arrow button once to scroll to "Custom Drills".

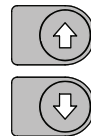

5. Press Enter twice.



6. Press and hold either up/down arrow until machine rotates and is horizontal with frame.
(The machine will be parallel with the baseline).



7. On the net system, slide back poles up before front poles – make sure the rings are as far down on the pole as they can be.

8. Slide the front poles upward until all the poles snap in place.

Height Adjustment on Net System:

Height	Pole Setting
11'	Bottom extension pole latched in hole 1.
11' 6"	Bottom extension pole latched in hole 2.
12'	Top extension pole extended until clip latches in pole. Bottom extension pole latched in hole 2.

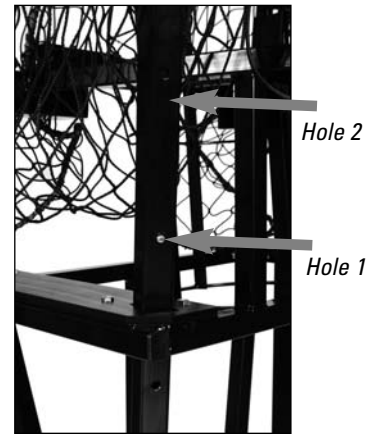
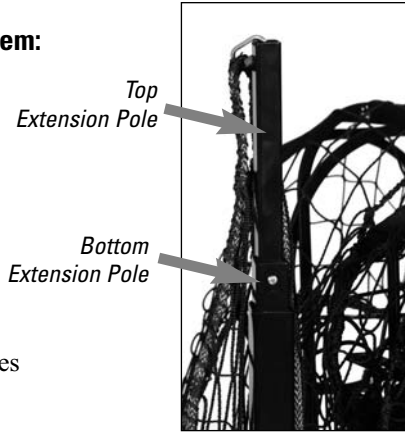

9. Place your hand on the horizontal handle and start to push in a downward motion. As this handle is being pushed down, reach with your left hand and grab the vertical handle and pull it towards you until it reaches the top position. The motion is a push on the horizontal handle and a pull on the vertical handle.

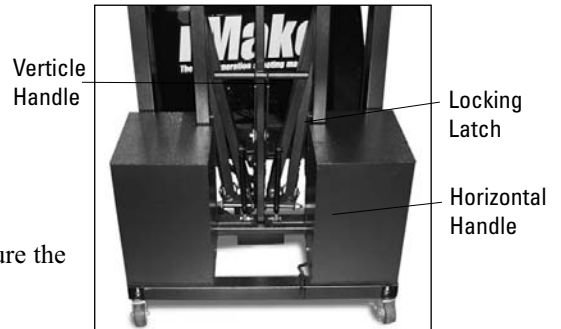

10. Once the net system snaps in place, flip the locking latch to secure the system.

11. Press Start to begin drill “Around the World” or press the Mode button to select a new drill. (See pages 14-26 for more information on modes and drills.)

Note: Machine is shipped in the horizontal position.

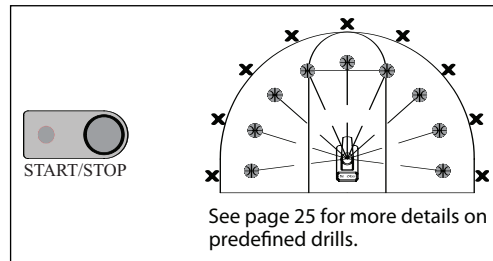

Around the World

Collapsing the Net System:

1. Press and hold the appropriate arrow button to rotate machine to horizontal position.
2. Power off machine, unplug and move machine clear of the backboard.
3. Release the locking latch.
4. Reverse the motion to setting up the net in #9. Push on the vertical handle and pull on the horizontal.
5. Release each pole by pressing the snap button and gently sliding each pole down.

Tightening the Net:

The adjustable bungee allows you to tighten the net to your requirement. As the net stretches, you can tighten the net by feeding the excess bungee cord (starting in the front center) towards the rear and then feeding the excess through the cord stop. Trim and singe the bungee cord as necessary.

Note: It is best for the bungee to be a little loose and not too tight.



Parts of the iMake

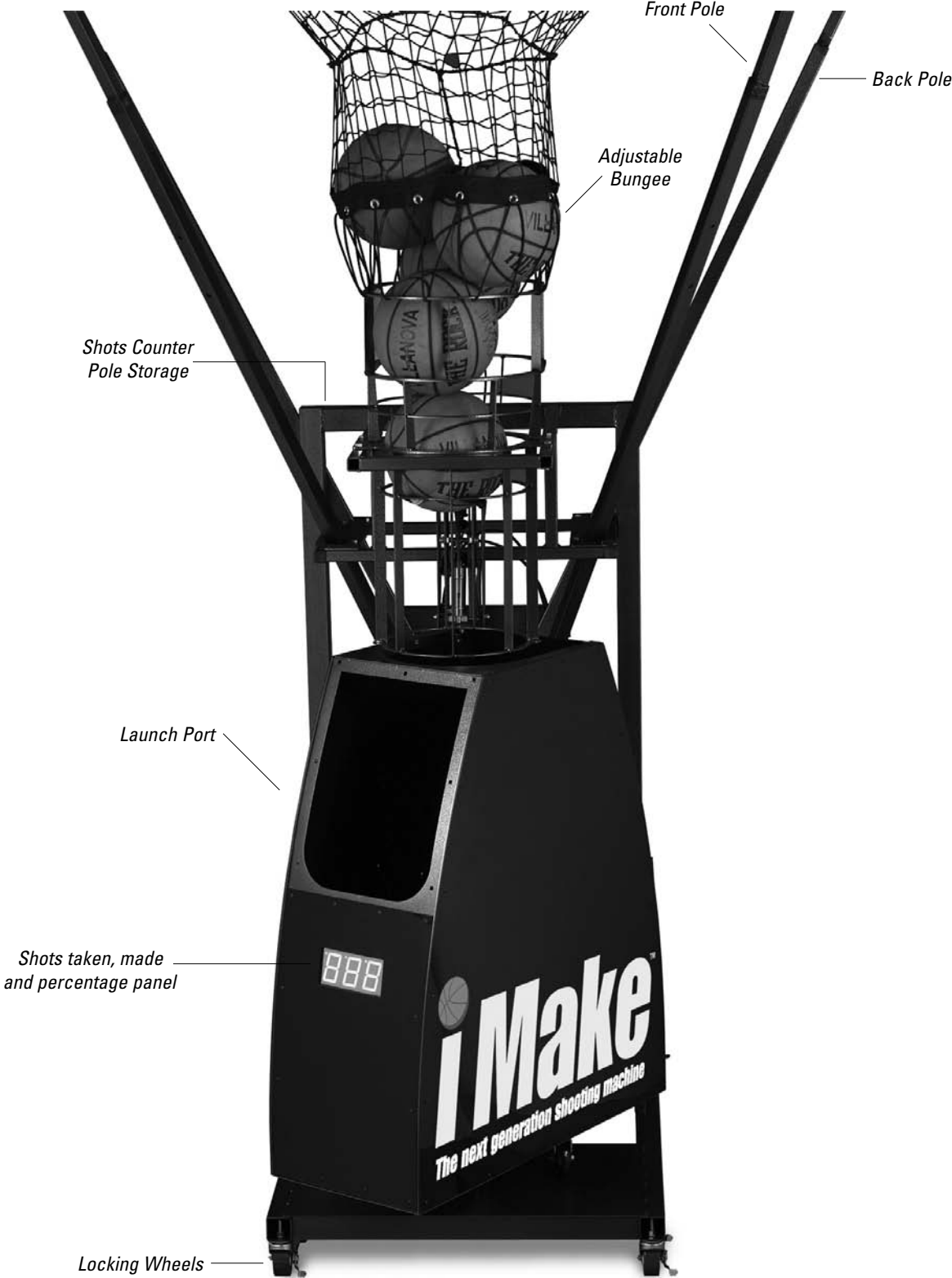

Consistent Air Technology

Balls are launched using the precise power of air. iMake can throw powerful passes well beyond the three-point line.

Court Smart™ Technology

Court Smart makes the iMake flexible and easy to use. iMake can throw a ball to any location at any speed at any tempo and within any rotation range. With Court Smart you can create and save your own drills.

Touch Pad Control Panel

The touch pad control panel will take you through step-by-step procedures when setting up drills.

The following pages will walk you through creating a password, using the timer mode, the remote mode, the teach mode or the multi-ball mode, setting up and saving custom drills, and using the predefined drills of the iMake with Court Smart Technology.

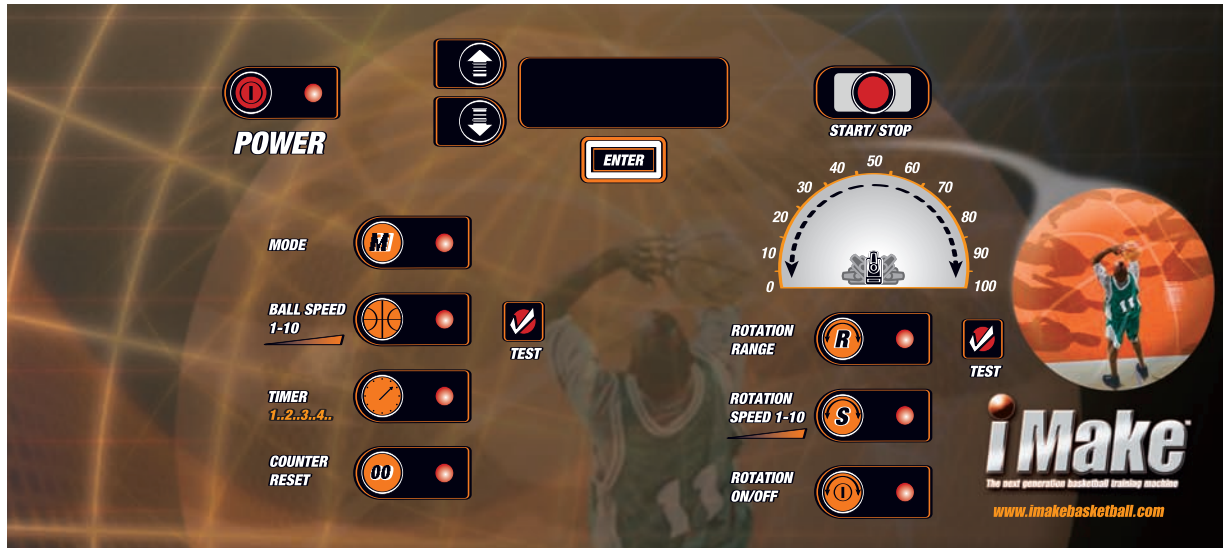

Caution

Do not put your hand in the launcher or ball feed mechanism.

Personal injury could result from placing hands in ball feed port or the launch port.

Do not stand too close to the ball feed launch area.

A ball may be thrown. A pre-toss beeper will warn the player when the ball is being thrown.

Remember to place the electrical cord where it is not a tripping hazard.

Machine Overview

Beeper

The iMake has a beeper to alert players when a ball is coming. Two quick beeps will alert the player before a ball is tossed.

Modes of operation

Timer Mode

See page 14 for operation instructions.

The timer setting will determine how often a ball is launched from iMake. The timer can be set from 1 to 20 seconds in increments of 1 second.

If you run out of balls, iMake will attempt 20 ball feeds before it goes into reset mode. You can reset the timer again by pressing the remote control button or pressing the start/stop button on the control panel. After the ball is tossed, a ball is automatically fed into the machine and the timer resets and begins countdown again.

You can use the remote control button to pause the timer operation. To pause, press the button on the remote once, press the remote button again to resume timer operation.

Remote Mode

See page 16 for operation instructions.

Remote control mode allows the coach (or player if training by themselves) the ultimate control over when the ball is delivered. Pressing the button on the remote delivers the ball. If there are no balls in the machine, but a ball is in the feeder, pressing the remote button once will load a ball. Pressing the remote button again (after the ball feeds) will launch the ball. It is not necessary to point the remote at the iMake, it will work within 100 feet of the machine.



Multi-ball Mode

See page 18 for operation instructions.

Multi-ball allows the user to select how many balls they want to throw within a selected rotation range. The balls are thrown in equal increments within the range. The minimum number of locations that can be selected is two, with balls being thrown at the end of each rotation. The maximum number of locations is twenty-one. A minimum of five increments (i.e. 10, 15, 20, etc.) is required between each location. For example: If you want to throw five balls to each elbow from under the basket, you would select Multi-ball, set the left range at 40 and the right range at 60, select two locations, five balls/location, and select the amount of time between throws. Each time iMake reaches 40 and 60 it will deliver five balls to each location. See Illustration I, Example 1 below.

See example 2 for additional uses of the Multi-ball Mode.

Illustration I

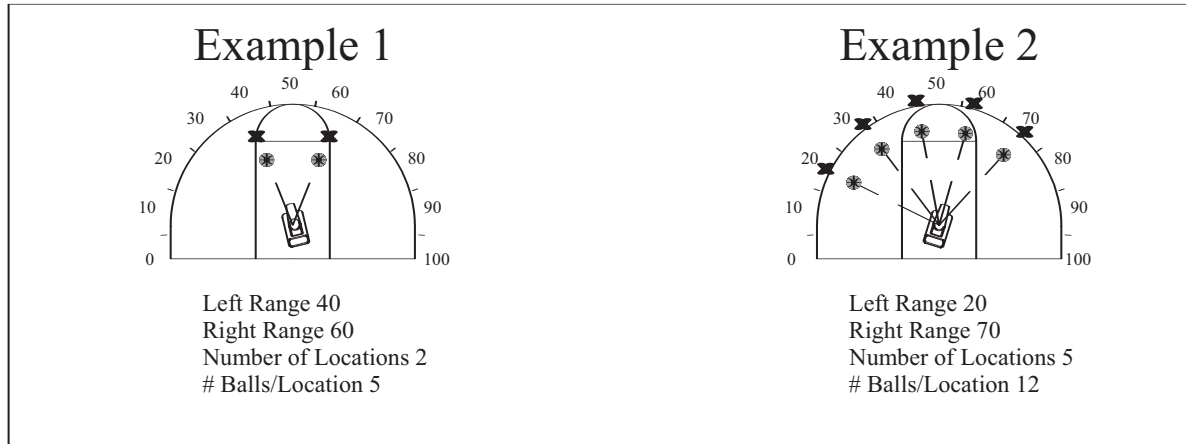

Teach Mode

See page 20 for operation instructions.

Teach mode gives the coach the ability to “teach” iMake where to throw a ball. In this mode, the coach has the flexibility of throwing balls to locations that are not of equal distance apart.

See Illustration II, example 1 and 2 below.

Illustration II

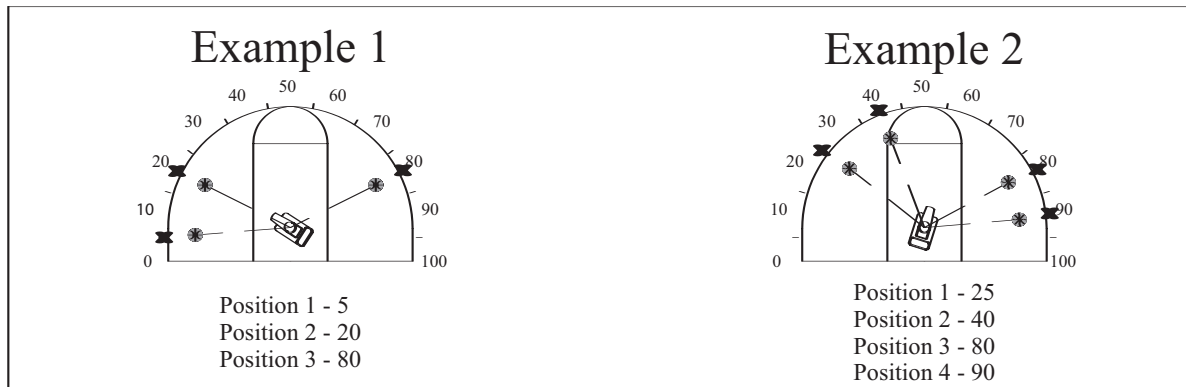

Custom Drills/Saving Your Drill

See page 22 for operation instructions.

Custom drills are drills that you have created and want to save into the iMake. Saving a drill saves the mode, ball speed, timer increment, rotation speed, rotation range and where to throw the balls. Fifty custom drills can be saved. You can keep the name "Custom 9" or change the name to something more descriptive like "High Post" or "Wing D1". You have 16 characters (letters or numbers) to use when naming a drill. When you select this drill as the mode, all the settings are set and you simply press start to begin. While running your selected drill, you can still change the settings to personalize it for each player.

Note: Eight of these drills are already predefined. (See page 24 for predefined drills). Each of these can be modified or a new drill saved in its place.

Predefined Drills

See pages 24-26 for illustrations and descriptions for each predefined drill.

iMake comes with eight predefined drills. You can locate these drills by selecting Custom Drills as your mode, and using the arrow buttons to scroll through the drills. The settings, such as ball speed, rotation range, rotation speed, etc., can each be changed to meet your personal needs and then saved to the machine. These predefined drills can also be overwritten by the drills that you have created. You will find these predefined drills under the mode "Custom Drills."

Adjustable Ball Speed

The ball speed on iMake can be adjusted within a range of 1 to 20, with 1 being the softest and 20 being the hardest. Ball speed can be increased /decreased during use by pressing the Ball Speed button and using the arrow buttons accordingly.

Adjustable Rotation

iMake has an adjustable rotation range that can be set to rotate in increments of 5 between 0 and 100, or the rotation can be turned off. iMake will easily rotate from baseline to baseline, or can be adjusted to any range of rotation within the baselines. For example, if you want a player to work just the baseline to the wing, you could set the range from 0 to 40 or 60 to 100. iMake will rotate within this rotation range until you change the range.

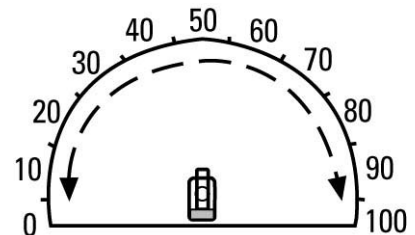

Manual Rotation

iMake can be rotated manually. To rotate manually, have iMake set up in a drill or mode. Press and hold down the top arrow button to have iMake rotate to the right, and the bottom arrow button to rotate to the left. Release the button when the machine has rotated to the desired position.

Test Buttons

On your control board, you will find a test button for Ball Speed and Rotation Range. After choosing a mode and selecting the settings, but before pushing Start, you can test both the ball speed and rotation range (if applicable) by pressing the appropriate test button.

Note: Use caution when testing ball speed, a ball will be thrown immediately after pressing button.

Remote

In addition to using the remote to deliver a ball, the remote can also be used to pause and restart any mode. This provides the coach even more control over the ball entry and allows them to stop and “coach” and then resume operation without having to physically go over to the machine.

You can also use the remote to bypass entering your password by pressing the button once.

Wireless Shots Made Counter (optional)

See page 27 for operation instructions.

The iMake counts shots taken while the shots made counter keeps track of shots made. With the shots made counter, the iMake has the ability to keep track of shots taken, shots made and shooting percentage. iMake will show the number of passes thrown (or shots taken) without the counter.



Reset the counter by pushing the counter reset button on the control panel.

Net System

See page 5-6 for operation instructions.

The net system automatically feeds made and missed shots back into the iMake. The net system can be easily collapsed for storage.

Mobile Stand

iMake is on wheels. It is not normally necessary to lock the wheels, but it is available if needed. To lock the wheels, press down on the "On" position of the lock until it is in the down position. To unlock, press down on the "Off" position of the lock.

Password

When using the iMake for the first time, you can either enter the default password of "999" or use your remote.

See the following instructions.

1. Press Power button.



POWER

iMAKE REV 4.2



ENTER PASSWORD

2. Enter the default password of "999" pressing Enter after each "9", or use your remote to unlock the iMake by pressing the button once.

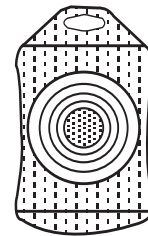

Changing Password

1. iMake must be in a mode or drill. (See page 28 for more details on entering the diagnostic menu.)
2. Enter Diagnostic Menu by holding down both arrow buttons for two seconds.
3. Use the down arrow button to scroll to the "PRESS ENTER TO VIEW PASSWORD" screen.
4. Press Enter.

5. Use the up/down arrow buttons to scroll through letters or numbers for your password.
Press the Enter button after each selected character.
Password must have three characters.

PASSWORD CHANGE
■ ■ ■

6. When done, use the down arrow button to scroll to the EXIT screen.
Press Enter to exit.

EXIT



Modes of Operation

Timer Mode

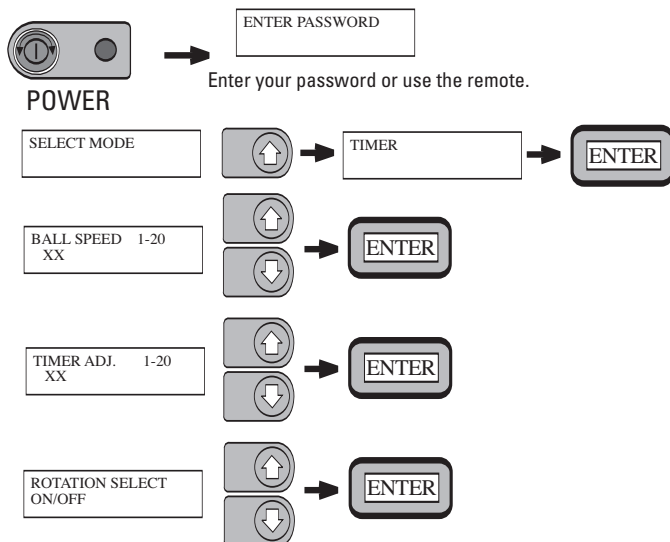

If you select OFF for rotation, you're ready to begin.

To test ball speed, press the TEST button. **CAUTION: A ball will be thrown immediately.**

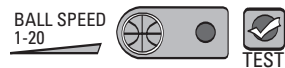

To begin, press the START button.



If you select ON for rotation, follow these menus.

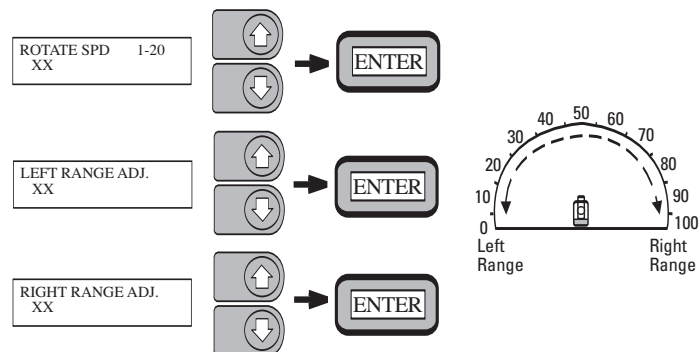

To test rotation range, press the TEST button. iMake will rotate from end point to end point.



To test ball speed, press the TEST button. **CAUTION: A ball will be thrown immediately.**

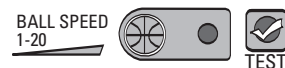

To begin, press the start button.



To change a setting

Select the setting you would like to change.
Use the up/down arrows to make changes to
any of the following settings, then press ENTER.

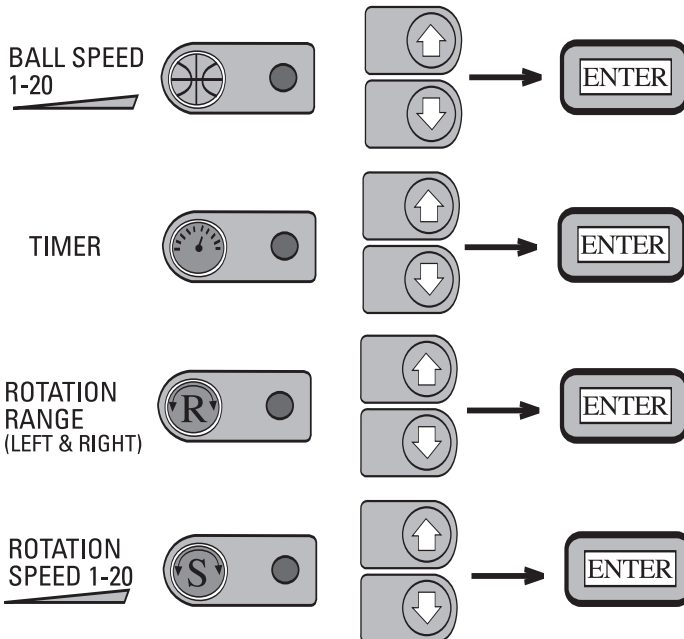

It is recommended to stop the machine before selecting rotation ON. Use the up/down arrows to change the left & right ranges pressing ENTER after each change.

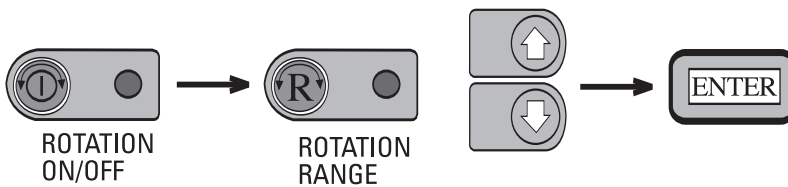

You must stop the machine before changing the MODE. Use the up/down arrows to select a different mode, then press ENTER.

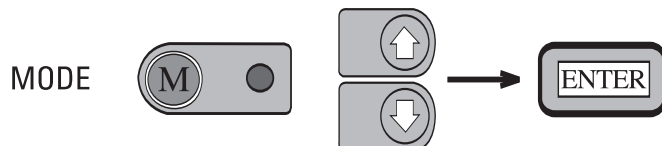

Remote Mode

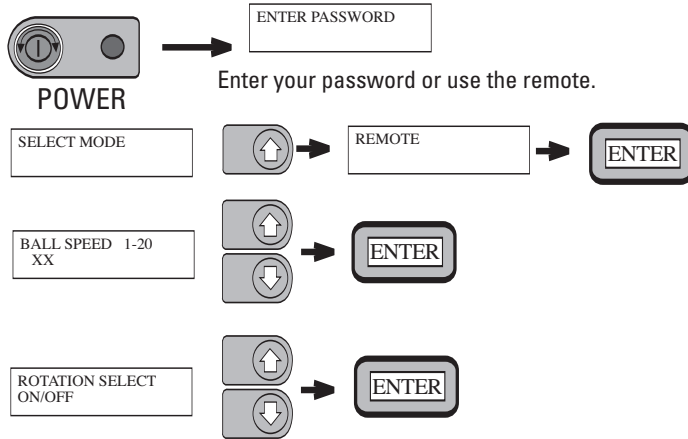

If you select OFF for rotation, you're ready to begin.

To test ball speed, press the TEST button. **CAUTION: A ball will be thrown immediately.**

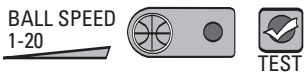

To begin, press the START button.



If you select ON for rotation, follow these menus.

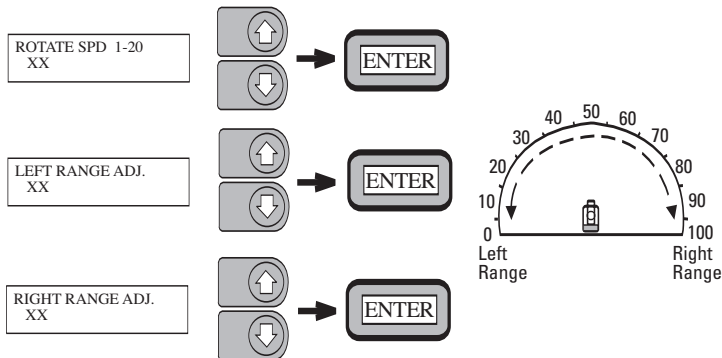

To test rotation range, press the TEST button. iMake will rotate from end point to end point.



To test ball speed, press the TEST button. **CAUTION: A ball will be thrown immediately.**

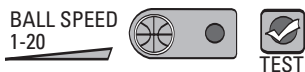

To begin, press the START button.



To change a setting

Select the setting you would like to change.
Use the up/down arrows to make changes to any of the following settings, then press ENTER.

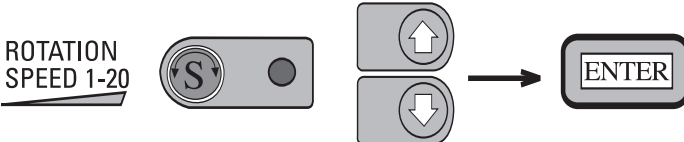
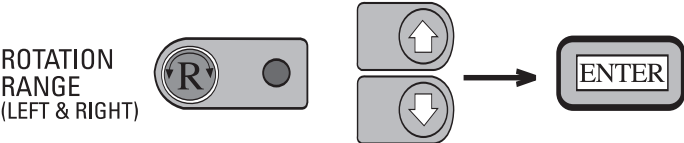
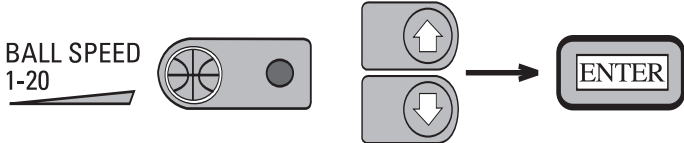

START/STOP

It is recommended to stop the machine before selecting rotation ON. Use the up/down arrows to change the left & right ranges pressing ENTER after each change.

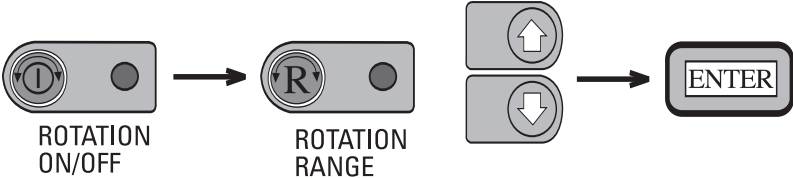

START/STOP

You must stop the machine before changing the MODE. Use the up/down arrows to select a different mode, then press ENTER.

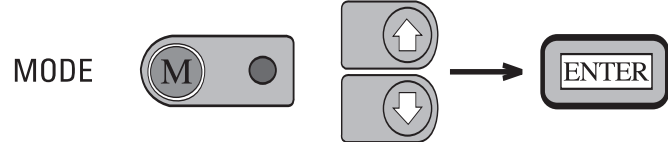

Multi-Ball Mode

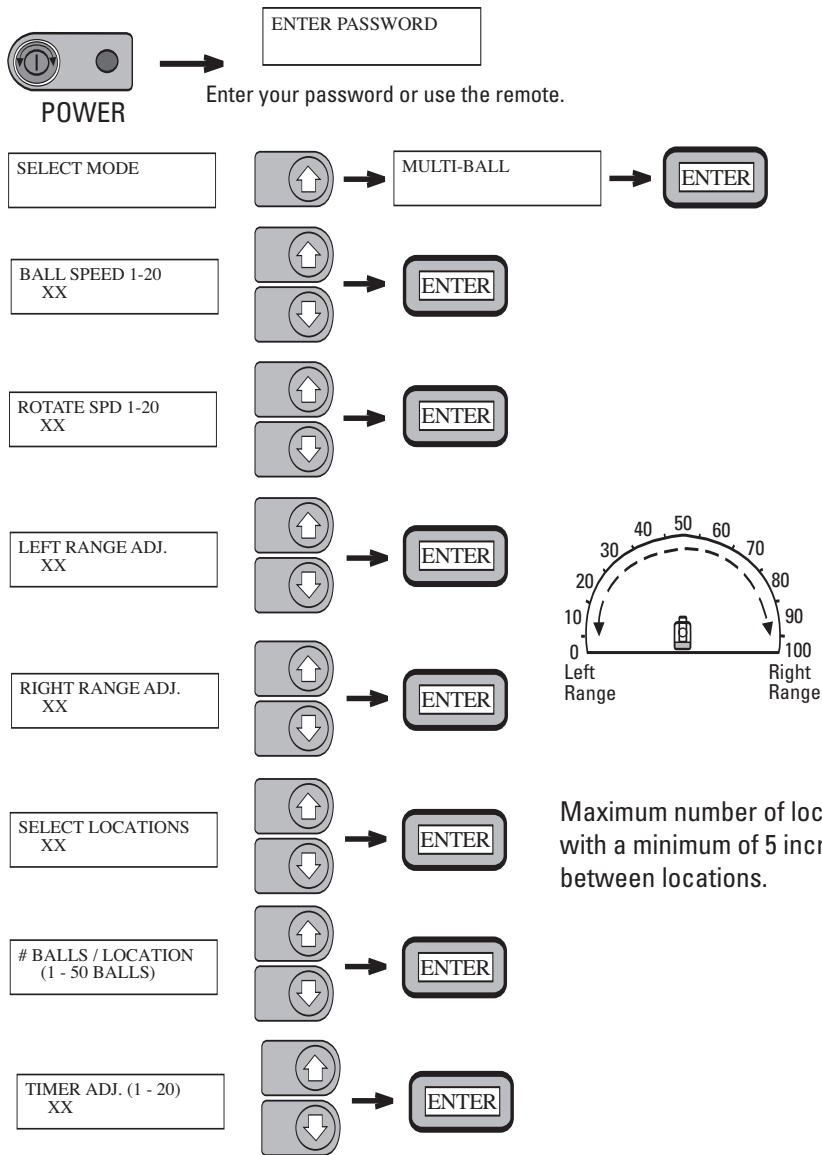

Maximum number of locations is 21, with a minimum of 5 increments between locations.

To test ball speed, press the TEST button.
CAUTION: A ball will be thrown immediately.

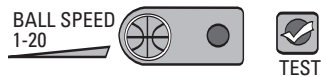

To test rotation range, press the TEST button.
iMake will rotate from end point to end point.



To begin, press the START button.

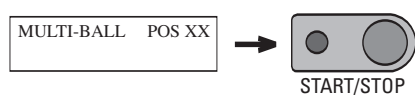

CAUTION: Once START is pressed, iMake will start throwing balls.

To change a setting

Select the setting you would like to change.
Use the up/down arrows to make changes to
any of the following settings, then press ENTER.

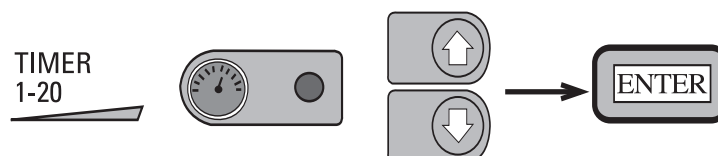
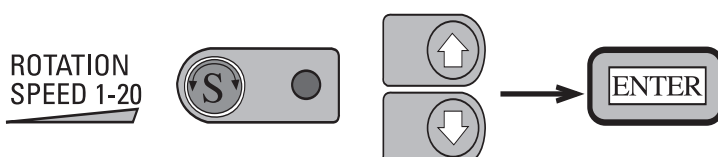
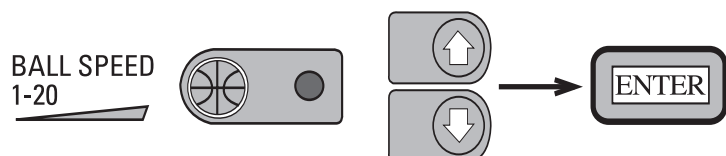

You must stop the machine to change the rotation range
or the number of locations. Press the MODE button and
select MULTI-BALL and follow the on-screen menus.

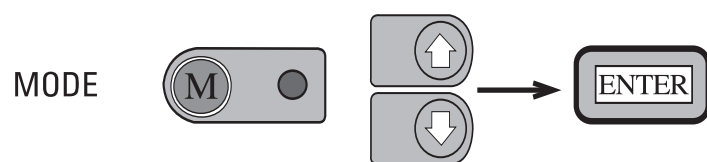

Teach Mode

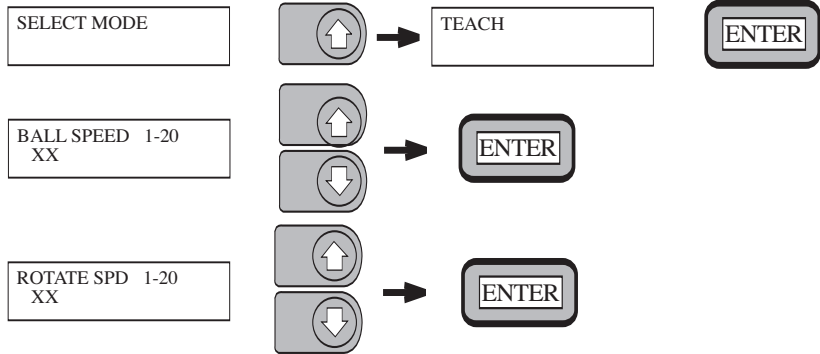
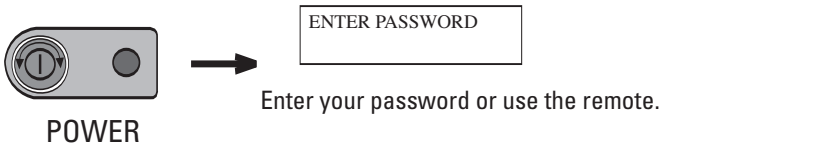

Watch menu screen for instructions.



Use up/down arrows to go to second throwing location. The distance between each throwing location must be at least 5 increments, the maximum number of locations is 21. Do this for each throwing location wanted, pressing ENTER after each one. When finished, press the ENTER button one more time to continue.

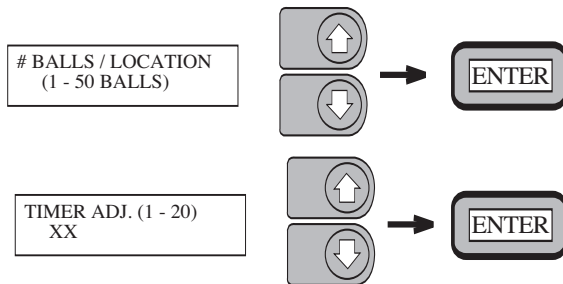

To test ball speed, press the TEST button.
CAUTION: A ball will be thrown immediately.

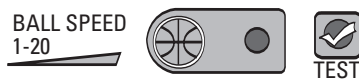

To test rotation range, press the TEST button.
iMake will rotate from end point to end point.



To begin, press the START button.

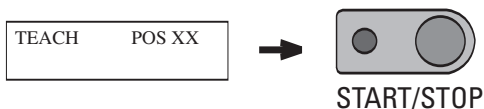

CAUTION: Once START is pressed, iMake will start throwing balls.

To change a setting

Select the setting you would like to change.
Use the up/down arrows to make changes to
any of the following settings, then press ENTER.

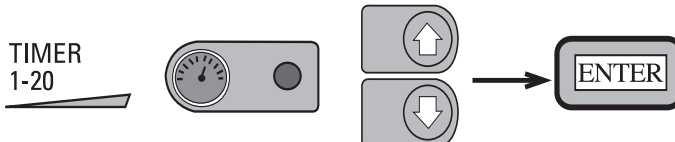
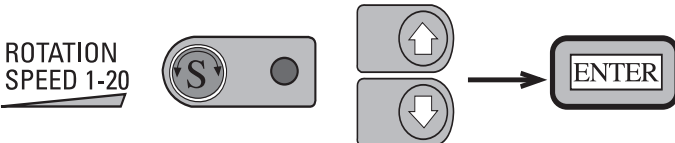
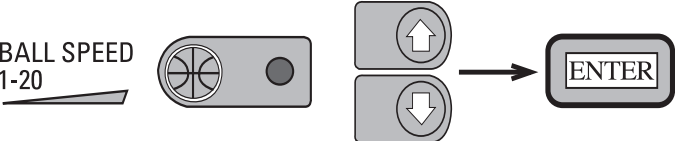

You must stop the machine to change the rotation range
or the number of locations. Press the MODE button and select
TEACH and follow the on-screen menus.

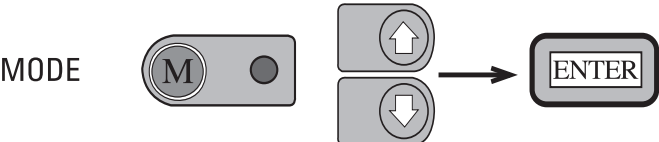

Save a Custom Drill

To save your drill, hold the ENTER button down until the screen changes. This will take about 5 seconds, then release the ENTER button.

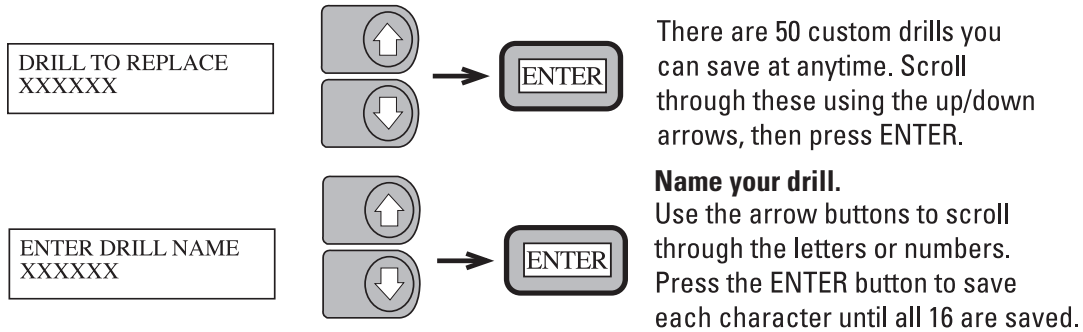

When the last character is saved, the custom drill will be saved and the screen will return to the current mode.

To find your saved drill

Press the MODE button. Using the up/down arrows, select Custom Drills, and press ENTER. Using the up/down arrows, scroll through the drills and select the one you saved. Press ENTER, then press START to begin the drill.

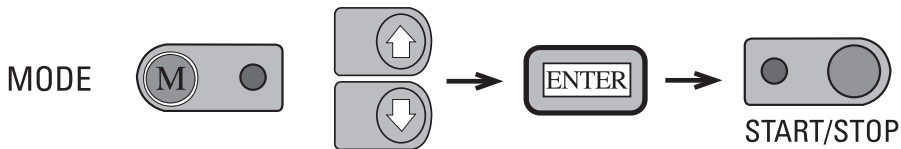

You can change a setting by going to the appropriate setting and following the “TO CHANGE A SETTING” instructions found on the following page.

To change a setting

Select the setting you would like to change.
Use the up/down arrows to make changes to
any of the following settings, then press ENTER.

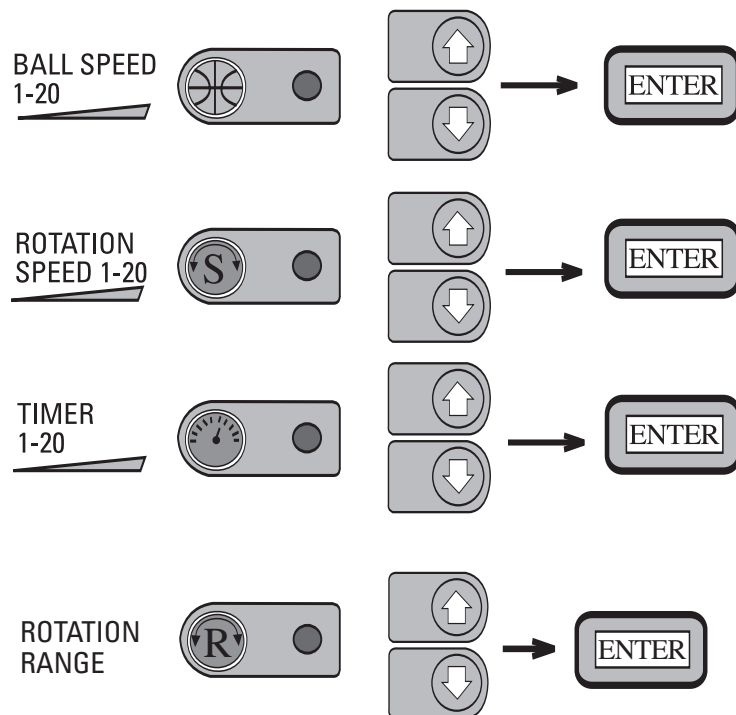

Note: Only for drills saved in remote or timer mode.



You must stop the machine before changing
the MODE. Use the up/down arrows
to select a different mode, then press ENTER.

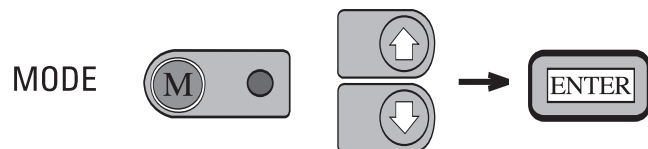

Predefined Drills

iMake comes with eight predefined drills, you can locate these drills by selecting Custom Drills as your mode, press enter and use the arrow buttons to scroll through the drills. The settings, such as ball speed, rotation range, rotation speed, etc., can each be changed to meet your personal needs and then saved to the machine. These predefined drills can also be overwritten by the drills that you have created. You will find these predefined drills under the mode “Custom Drills.”

See the illustrations on the following pages for more information on each predefined drill.

1. **Around the World** – iMake will throw one ball to nine locations.
2. **Around the World 2** – iMake will throw five balls to five locations.
3. **Elbows** – iMake will throw one ball to each elbow.
4. **Free Throw** – iMake will throw a ball every seven seconds to free throw line.
Note: Manually rotate iMake to free throw line using up/down arrows.
5. **Wings** – iMake will throw a ball to each wing.
6. **Top of Key** – iMake will throw two balls to five locations around the top of the key.
7. **Left Side** – iMake will throw two balls to four locations between the baseline and the left wing.
8. **Right Side** – iMake will throw two balls to four locations between the baseline and the right wing.

Predefined Drills

Around the World

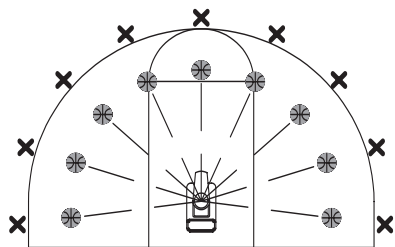

1 Ball per location

SETTINGS:

BALL SPEED = 12
 TIMER = N/A
 ROTATION ON/OFF = ON
 ROTATION SPEED = 15
 ROTATION RANGE (LEFT) = 0
 ROTATION RANGE (RIGHT) = 100
 NUMBER OF LOCATIONS = 9
 NUMBER OF BALLS AT EACH LOCATION = 1
 TIMING BETWEEN BALLS = N/A

Around the World 2

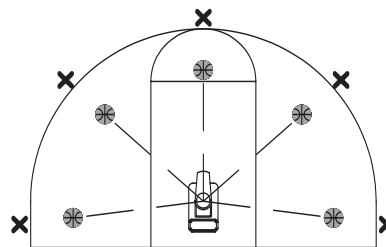

5 Balls per location

SETTINGS:

BALL SPEED = 12
 TIMER = N/A
 ROTATION ON/OFF = ON
 ROTATION SPEED = 20
 ROTATION RANGE (LEFT) = 0
 ROTATION RANGE (RIGHT) = 100
 NUMBER OF LOCATIONS = 5
 NUMBER OF BALLS AT EACH LOCATION = 5
 TIMING BETWEEN BALLS = 4

Elbows

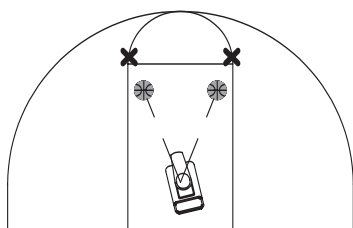

1 Ball per location

SETTINGS:

BALL SPEED = 10
 TIMER = N/A
 ROTATION ON/OFF = ON
 ROTATION SPEED = 20
 ROTATION RANGE (LEFT) = 40
 ROTATION RANGE (RIGHT) = 60
 NUMBER OF LOCATIONS = 2
 NUMBER OF BALLS AT EACH LOCATION = 1
 TIMING BETWEEN BALLS = N/A

Free Throw

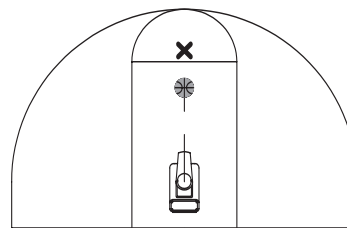

Note: Manually rotate iMake to free throw line.

SETTINGS:

BALL SPEED = 5
 TIMER = 7
 ROTATION ON/OFF = OFF
 ROTATION SPEED = N/A
 ROTATION RANGE (LEFT) = N/A
 ROTATION RANGE (RIGHT) = N/A
 NUMBER OF LOCATIONS = N/A
 NUMBER OF BALLS AT EACH LOCATION = N/A
 TIMING BETWEEN BALLS = N/A

N/A = NON-APPLICABLE

Predefined Drills

Wings

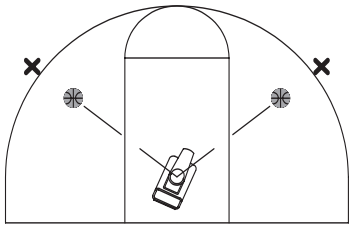

1 Ball per location

SETTINGS:

BALL SPEED = 12
 TIMER = N/A
 ROTATION ON/OFF = ON
 ROTATION SPEED = 20
 ROTATION RANGE (LEFT) = 25
 ROTATION RANGE (RIGHT) = 75
 NUMBER OF LOCATIONS = 2
 NUMBER OF BALLS AT EACH LOCATION = 1
 TIMING BETWEEN BALLS = N/A

Top of Key

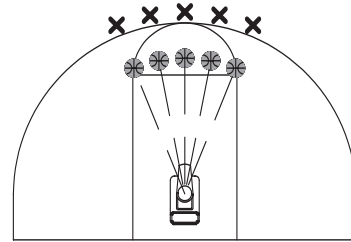

2 Balls per location

SETTINGS:

BALL SPEED = 12
 TIMER = N/A
 ROTATION ON/OFF = ON
 ROTATION SPEED = 20
 ROTATION RANGE (LEFT) = 40
 ROTATION RANGE (RIGHT) = 60
 NUMBER OF LOCATIONS = 5
 NUMBER OF BALLS AT EACH LOCATION = 2
 TIMING BETWEEN BALLS = 3

Left Side

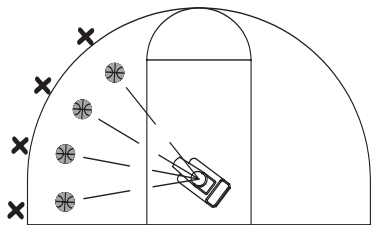

2 Balls per location

SETTINGS:

BALL SPEED = 12
 TIMER = N/A
 ROTATION ON/OFF = ON
 ROTATION SPEED = 20
 ROTATION RANGE (LEFT) = 0
 ROTATION RANGE (RIGHT) = 30
 NUMBER OF LOCATIONS = 4
 NUMBER OF BALLS AT EACH LOCATION = 2
 TIMING BETWEEN BALLS = 3

Right Side

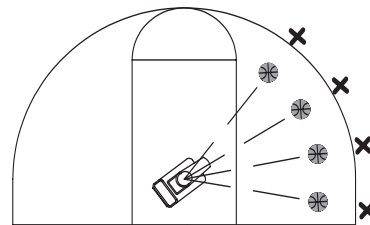

2 Balls per location

SETTINGS:

BALL SPEED = 12
 TIMER = N/A
 ROTATION ON/OFF = ON
 ROTATION SPEED = 20
 ROTATION RANGE (LEFT) = 70
 ROTATION RANGE (RIGHT) = 100
 NUMBER OF LOCATIONS = 4
 NUMBER OF BALLS AT EACH LOCATION = 2
 TIMING BETWEEN BALLS = 3

N/A = NON-APPLICABLE

Shots Made Counter and Pole (optional)

The iMake counts shots taken while the shots made counter keeps track of shots made. With the shots made counter, the iMake has the ability to keep track of shots taken, shots made and shooting percentage. The iMake will show the number of passes thrown (or shots taken) without the counter.

Storage:

The shots made pole is used to raise and lower the counter up to and down from the basket. It is stored in the frame of the net system. See page 7 to identify location.

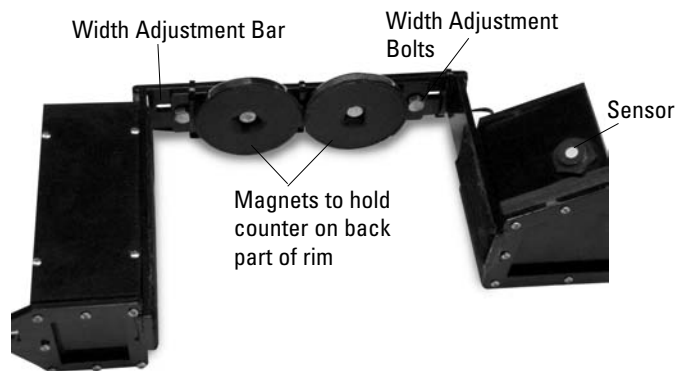

Using the Shots Made Counter

1. The shots made plug must be plugged into the receptacle on counter.
Note: Make sure to unplug the counter when not in use.
2. Use the shots made pole to raise and place counter on top of the flat part of the rim. The back of the counter needs to be against the backboard. **Note:** If you have padding around your backboard, you may need to pull the counter a half inch away from the backboard to allow the counter to sit level on the rim.
3. The electronic sensor eye needs to face the court and be level on the rim.
4. Turn on the iMake.

To adjust the width of the counter – loosen, but do not remove, the four bolts on the bracket. Adjust bracket to fit the width of your basket.

Charging the Shots Made Counter

1. To charge the battery on the counter, take the counter down from the rim, unplug shots made plug from receptacle, insert the battery charger plug into the receptacle and then plug into outlet. The counter is fully charged when the light on the base charger is green.
2. It is recommended to recharge the battery on the counter after each use. If this is not possible, **make sure to unplug the shots made plug from the receptacle to save on current charge.**

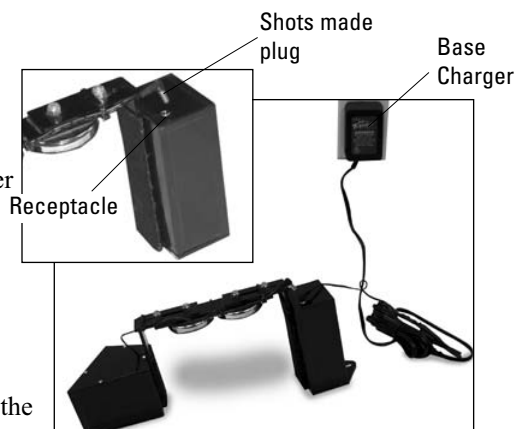

To Ensure an Accurate Reading:

1. Set up counter before turning on the iMake. (If you have been using the iMake before setting up the shots made counter, restart machine by pressing the power button.)
2. Make sure the counter is level on the rim, and the electronic sensor is facing the court. The electronic sensor will not read correctly if it is tilted upward or downward.
3. Make sure the battery is charged on the shots made counter. This is indicated by a green light on the base charger. **(To maintain battery life, unplug shots made plug from receptacle after every use. Charging battery after every use is recommended.)**

Resetting Counter

Press “Counter Reset” button on iMake control panel to reset counter at anytime.



Diagnostic Menu

To Enter Diagnostic Menu

1. Be in a mode with settings selected.

For example: Select Remote Mode. Press the ENTER button three times to scroll through settings, ball speed and rotation select.

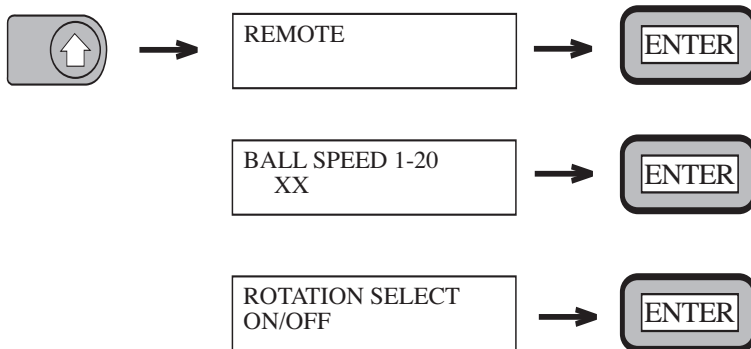

2. Press and hold both arrow buttons at the same time for two seconds and release.
The diagnostic menu will then be displayed.



3. Use the down arrow button to scroll through diagnostic menu.
Press the ENTER button to view any of these screens.



These are the different screens on the Diagnostic menu.

- | | | | |
|---|---------------------------------|---|-------------------------------|
| 1 | RESET PARAMETERS
PRESS ENTER | 5 | DISPLAY MODE
PRESS ENTER |
| 2 | VOLTAGE
xx.xxV | 6 | DISPLAY TEST |
| 3 | DISPLAY STATS | 7 | BALL FEED TEST
BALL LOADED |
| 4 | PRESS ENTER TO
VIEW PASSWORD | 8 | EXIT |

Diagnostic Menu Descriptions

1. Reset Parameters – For technical support only.
2. Voltage – Reads current voltage from power source.
3. Display Stats – Press Enter to view stats, using the arrow buttons to view Total Shots and Run Time. These are the lifetime stats of the machine.
4. Press Enter to View Password – Use this selection to view the password or to change it. Use the arrow buttons to change characters, pressing Enter after each one. Only three characters are used for the password.
5. Display Mode – Controls front board display. By selecting Shots Taken, iMake will only show the amount of passes that the iMake has thrown (or shots taken). By selecting Cycle Display, iMake will cycle through shots taken, shots made, and shooting percentage. Cycle Display will only work if Shots Made Counter has been purchased.
6. Display Test – Tests LED lights on front board display.
7. Ball Feed Test – Will display Ball Loaded or Ball Not Loaded. Press Enter to test ball feed.
8. Exit.

Trouble Shooting

“System Error 6” – If this error message occurs, iMake is outside of rotation range. To bring iMake back into range, have machine on, press and hold either arrow button until machine rotates and is lined up inside baseline to baseline rotation range.

Ball Feed Error – If this error message occurs, restart machine. This will happen if there are no balls in machine, and iMake has tried to feed a ball twenty times.

iMake Warranty Information

Warranty: Airborne Athletics, Inc. offers to the original purchaser a lifetime warranty on the frame and three year warranty on parts.

This warranty policy covers all parts excluding the net which is covered by a separate one year warranty. Vandalism or other damage to the equipment, which is not considered normal use, is excluded.

Serial Number: _____

Date of Purchase: _____

Airborne Athletics, Inc.
888-887-7453
www.iMakebasketball.com